

Uniden

To activate the Caller ID feature, you must subscribe through your telephone company.



EX12960/2965

900 MHz CORDLESS

*with caller id/call waiting**

owner's manual



Welcome

Congratulations on your purchase of the Uniden EXI2960 (white) or EXI2965 (charcoal) cordless telephone. This phone is designed and engineered to exacting standards for reliability, long life, and outstanding performance.

Note: Some illustrations in this manual may differ from the actual unit for explanation purpose.

Features

- 900 MHz Extended Range Technology
- 3 Line Backlit Display
- Caller ID and Call Waiting Caller ID
- 10 Number Memory Dialing
- Face Up/Face Down Charging
- 32 Digit Redial
- Flash and Pause
- Tone/Pulse Dialing
- Page/Find
- 7 Hour Talk Time/14 Day Standby Time
- Handset Earpiece and Ringer Volume Control
- Hearing Aid Compatible
- 40 Channel Autoscan

The EXI2960/EXI2965 features include **AutoTalk™** and **AutoStandby™**. *AutoTalk* allows you to answer a call by just removing the handset from the base so you don't have to waste time pushing buttons or flipping switches. *AutoStandby* allows you to hang up by simply returning the handset to the base.

The **UltraClear Plus™** true compander circuitry virtually eliminates background noise. This innovative technology, together with 40 different channels, provides you with the best possible reception during all your conversations.

To protect you against misbilled calls which might result from your phone being activated by other equipment, the EXI2960/EXI2965 has **Random Code™** digital security which automatically selects one of over 65,000 digital security codes for the handset and base. Also, the **AutoSecure™** feature electronically locks your phone when the handset is in the base.

Be sure to visit our web site: www.uniden.com

Uniden® is a registered trademark of Uniden America Corporation.

AutoTalk, AutoStandby, UltraClear Plus, Random Code, and AutoSecure are trademarks of Uniden America Corporation.

Contents

Welcome/Features

Controls and Functions 2

Getting Started

Read this First	3
Checking the Package Contents	4
Setting up the Phone	5
Mounting the Base Unit on a Wall	10
Setting Caller ID Options	12
Entering Your Area Code	13

Basics

Making and Receiving Calls	14
Terminology	14
Adjusting the Handset Ringer and Earpiece Volume	15
Redial	15
Tone Dialing Switch-over	15
Traveling Out-of-Range	16
Selecting a Different Channel	16
Page	16
Flash and Call Waiting	16

Memory Dialing

Storing Phone Numbers and Names	17
Steps for Entering Names and Special Characters	18
Making Calls with Memory Dialing	19
Chain Dialing	20
Editing a Stored Name and/or Phone Number	20
Erasing a Stored Name and Phone Number	21

Caller ID Features

Caller ID	22
When the Telephone Rings	22
Viewing the Caller ID Message List	23
Deleting Information from the Caller ID List	23
Using the Caller ID List	25

Additional Information

Changing the Digital Security Code	27
Installing the Beltclip	28
Headset Installation	28
Note on Power Sources	29
Maintenance	29
Troubleshooting	30
General Information	31
Index	33

Controls and Functions

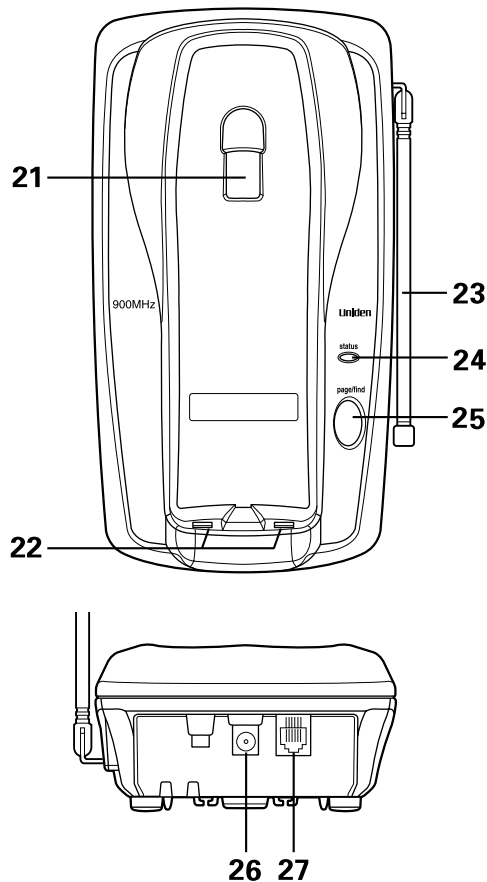
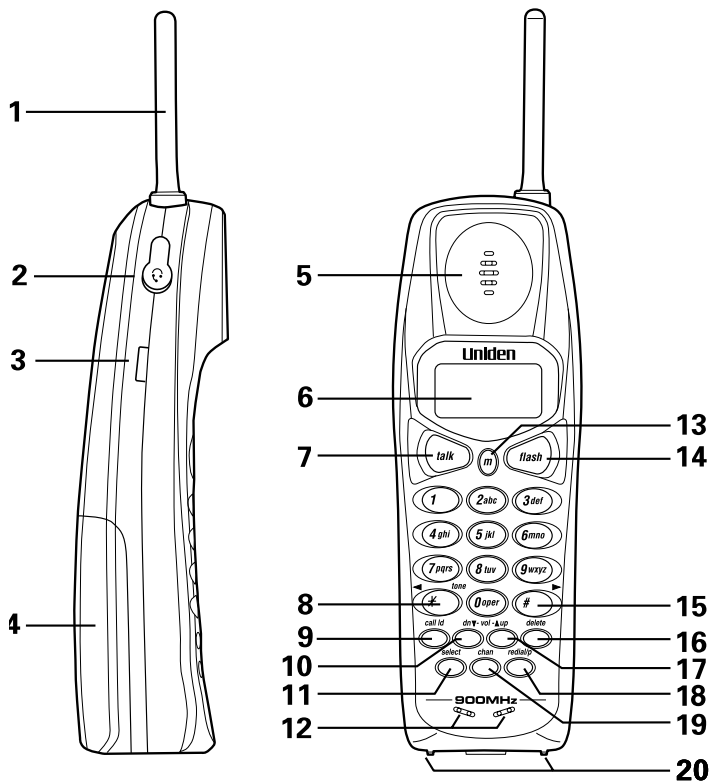

1. Handset antenna
2. Optional headset jack
3. Beltclip holes
4. Handset battery compartment
5. Handset earpiece
6. LCD display
7. Talk key
8. */left cursor (◀)/tone key
9. Caller ID key
10. Volume down ▼ key
11. Select key
12. Handset microphone and ringer speaker
13. Memory (m) key
14. Flash key
15. #/right cursor (▶) key
16. Delete key
17. Volume up ▲ key
18. Redial/pause (p) key
19. Channel (chan) key
20. Handset charging contacts
21. Handset retainer clip
22. Base charging contacts
23. Base antenna
24. Status LED
25. Page/find key
26. DC power input
27. Telephone line jack

Read this First

This cordless telephone must be set up before use. Follow these steps:

Step 1 (page 4)

Unpack the telephone and accessories.

Step 2 (page 5)

Next, choose the best location to set up the base unit.

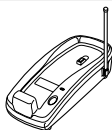

Step 3 (page 6 to 9)

Then, insert the battery pack into the handset. Connect the base unit. You must charge the battery pack for **15-20 hours before plugging into the telephone line and using the phone.**



Step 4 (page 12 to 13)

Finally, set the Caller ID options and store your area code in the memory to use the Caller ID service.



Note: Skip the area code setting if your calling area requires 10-digit dialing.

About the digital security code

This cordless telephone uses a digital security code to prevent unauthorized access to your base unit. This security code prevents other cordless handset from making calls through your base unit.

A random security code will be assigned automatically between your base unit and handset when you charge the battery pack for the first time.

If you want to reset the security code, see page 27.

Checking the Package Contents

Make sure you have received the following items in the package. If any of these items are missing or damaged, contact the Uniden Parts Department.

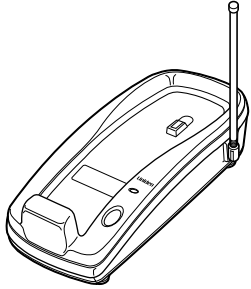

• Base unit



• Handset

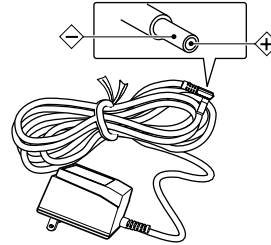

• AC adapter

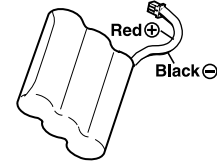

• Rechargeable battery

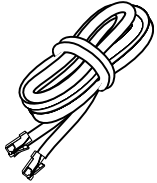

• Telephone cord

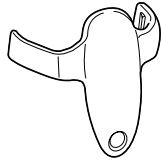

• Beltclip

Also included:

- This Owner's Manual
- Quick Reference Guide
- Precautions and Important Safety Instructions/Warranty Information
- Other Printed Material

Uniden Parts Department at (800) 554-3988
Hours: M-F 7:00 a.m. to 5:00 p.m. CST. We can also be reached on the web at www.uniden.com

Setting up the Phone

Do the following steps:

- A. Choose the best location
- B. Install the battery pack
- C. Connect the base unit
- D. Choose the dialing mode

A. Choose the best location

Before choosing a location for your new phone, read the **INSTALLATION CONSIDERATIONS** included in the **PRECAUTIONS AND IMPORTANT SAFETY INSTRUCTIONS** brochure. Here are some important guidelines you should consider:

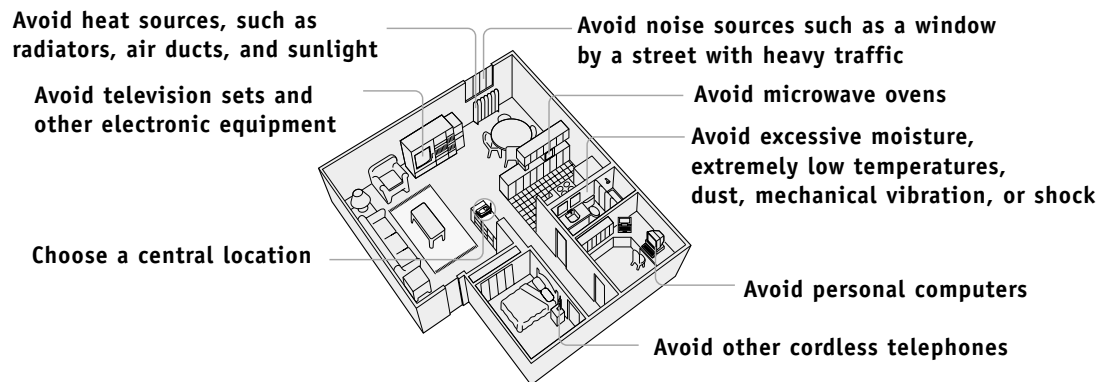

- The location should be close to both a phone jack and a continuous power outlet which is not switchable.
- Keep the base and handset away from sources of electrical noise such as motors, microwave ovens, and fluorescent lighting.
- Be sure there is sufficient space to raise the base antenna to a vertical position.
- The base can be placed on a desk, tabletop, or mounted on a standard wall plate.



Use only the Uniden battery (BT-905) supplied with your phone. Replacement batteries are also available through the Uniden Parts Department. (See page 4.)

B. Install the battery pack

Charge the battery pack for at least 15-20 hours before plugging the phone line into your phone.

- 1) Press in on the battery cover release and slide the cover down until it comes off.
- 2) Connect the battery pack connector observing correct polarity (black and red wires) to the jack inside the battery compartment.

Do not exert any force on this connection. It could cause damage to the battery or to the handset. The plastic connectors will fit together in only one way. Once you are certain that you have made a good connection, then insert the battery pack into the battery compartment. Do not pinch the wires.

- 3) Securely close the battery compartment cover by sliding it up until it snaps into place.
- 4) Place the handset on the base. Remove the beltclip, if attached, for face up charging.

Battery use time (per charge)

From fully charged

- Seven hours continuous use
- Fourteen days when the handset is in the standby mode

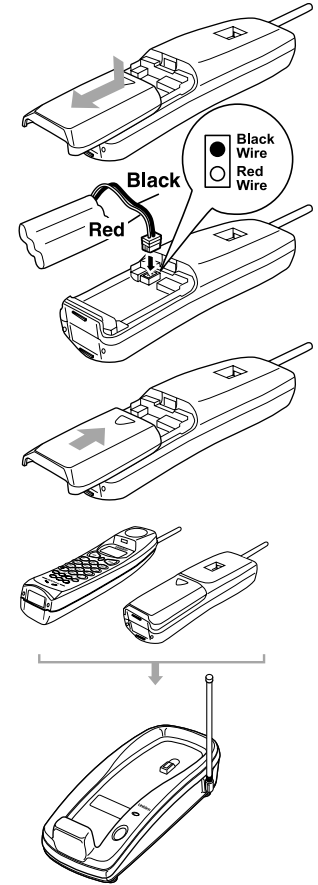

Low Battery Alert

When the battery pack is very low and needs to be charged, the phone is programmed to eliminate functions in order to save power. If the phone is not in use, "Low Battery" appears on the LCD and none of the keys will operate.

If the phone is in use, "Low Battery" flashes and the handset beeps. Complete your conversation as quickly as possible and return the handset to the base unit for charging.



The last number dialed in the redial memory, the names and the numbers stored in the memory locations are retained for up to 30 minutes while you replace the battery pack.

Cleaning the Battery Charging Contacts

To maintain a good charge, it is important to clean the battery contacts on the handset and base unit with a dry cloth or a pencil eraser about once month. Do not use any liquids or solvents.

C. Connect the base unit

- 1) Connect the AC adapter to the **DC IN 9V** jack and to a standard 120V AC wall outlet.

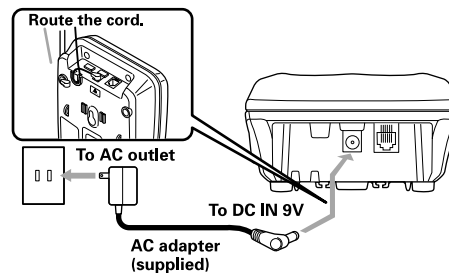
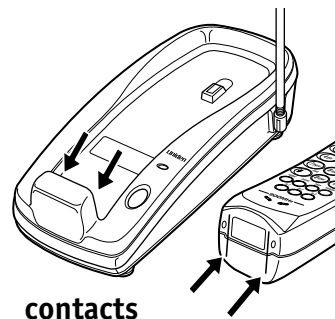
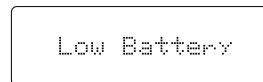

- Even when the battery pack is not being used, it will gradually discharge over a long period of time. For optimum performance, be sure to return the handset to the base unit after a telephone call.
- If you must replace the battery pack during a telephone call, complete the replacement of the battery pack within 30 seconds, and you can return to the original call.

note

- The handset can be placed up or face down in the base for charging.
- You have to remove the beltclip, if attached for face up charging.

!

Place the power cord so that it does not create a trip hazard or where it could become chafed and create a fire or electrical hazard.

2) Set the base on a desk or tabletop, and place the handset on the base unit as shown. Remove the beltclip, if attached, for face up charging. (See "Mounting the Base Unit on a Wall", on page 11.)

3) Then raise the antenna to a vertical position.

4) Make sure that the **status** LED lights. If the LED does not light, check to see that the AC adapter is plugged in and that the handset makes good contact with the base charging contacts.

note

- Use only the supplied AD-310 AC adapter. Do not use any other AC adapter.
 - Connect the AC adapter to a continuous power supply.
 - Place the base unit close to the AC outlet so that you can unplug the AC adapter easily.
- After installing the battery pack in the handset, charge your handset at least **15-20 hours before plugging into the phone line**. Once the handset battery pack is fully charged, connect the telephone line cord to the base and telephone wall outlet.

tip

If your telephone outlet isn't modular, contact your telephone company for assistance.

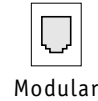
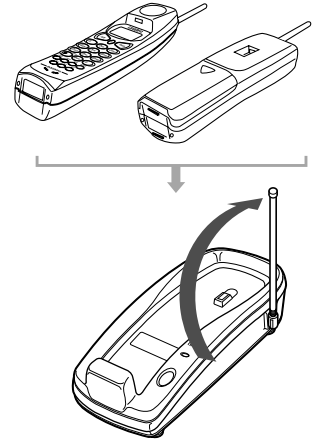

Modular

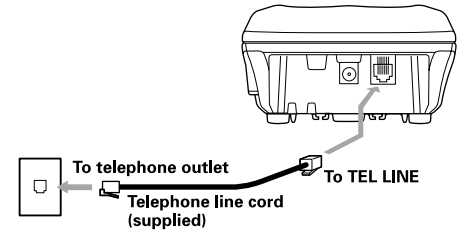

D. Choose the dialing mode

Most phone systems use tone dialing which sends DTMF tones through the phone lines. However some phone systems still use pulse dialing such as in rural areas. The default setting is tone dialing. Depending on your dialing system, set the mode as follows:

1) Press and hold **flash** until you hear a confirmation tone.

The current setting appears next to Dial Mode.

2) To set the dial mode for pulse dialing, press **#** ►.

```
Dial Mode: Tone
Tone - Press *
Pulse - Press #
```

Or to set the dial mode for tone dialing, press ***/tone** ◀. A confirmation tone sounds to indicate the setting is complete.

- If you are not sure of your dialing system, set for tone dialing. Make a trial call. If the call connects, leave the setting as is, otherwise set for pulse dialing.
- If your phone system requires pulse dialing and you need to send the DTMF tones for certain situations during a call, you may “switch-over” to tone dialing. (Refer to “Tone Dialing Switch-over” on page 15.)



Make sure your battery pack is fully charged before choosing the dial mode.

Mounting the Base Unit on a Wall

Setting the handset retainer clip for wall mounting

- 1) On the base unit, pull the handset retainer clip out of the slot and rotate it clockwise 180 degrees.
- 2) Flip the retainer clip from front to back. Slide it back into the slot so that the lip of the retainer is up and the ▼ is down. The retainer holds the handset in place.

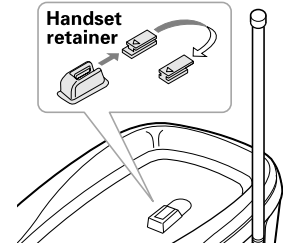

DO NOT use an outlet controlled by a wall switch.



If you have wall mounted the base, you have to remove the belt-clip to hang the handset with the display facing forward.

Standard wall plate mounting

This phone can be mounted on any standard wall plate.

- 1) Plug the AC adapter into the **DC IN 9V** jack.
- 2) Wrap the AC adapter cord inside the molded wiring channel as shown.
- 3) Plug the AC adapter into a standard 120V AC wall outlet.
- 4) Place the handset on the base unit and charge for 15-20 hours.
- 5) Plug the telephone line cord into the **TEL LINE** jack. Wrap the cord inside the molded wiring channel as shown.
- 6) Plug the telephone line cord into the telephone outlet.
- 7) Raise the antenna to a vertical position.
- 8) Align the mounting slots on the base with the mounting posts on the wall. Then push in and down until the phone is firmly seated.

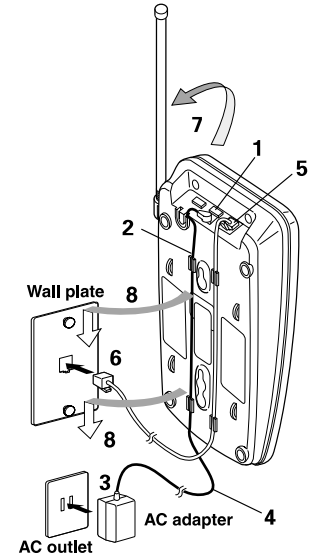

Direct wall mounting

If you don't have a standard wall plate, you can mount your phone directly to the wall. Before doing this, consider the following:

- Avoid electrical cables, pipes, or other items behind the mounting location that could cause a hazard when inserting screws into the wall.
- Try to mount your phone within 5 feet of a working phone jack to avoid excessive cord lengths.
- Make sure the wall material is capable of supporting the weight of the base and handset.
- Use #10 screws (minimum length of 1-3/8 inches) with anchoring devices suitable for the wall material where the base unit will be placed.

1) Insert two mounting screws into the wall, (with their appropriate anchoring device), 3-15/16 inches apart. Allow about 1/8 of an inch between the wall and screw heads for mounting the phone.

2) Set the retainer clip if necessary.

3) Refer to steps 1 through 8 on page 10 to mount the telephone.

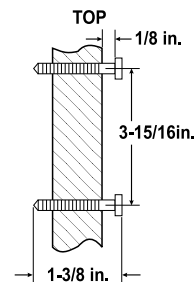

Setting Caller ID Options

There are three Caller ID setup options available. They are AutoTalk, CIDCW (Caller ID on Call Waiting), and Area Code. See page 13 for Area Code setup instructions.

AutoTalk allows you to answer the phone without pressing the **talk** button. If the phone rings when AutoTalk is on, simply remove the handset from the base and the phone automatically answers the call. Or if the handset is not on the base, press any key to answer the call. If the phone rings when AutoTalk is off, you must press **talk** to answer the call.

To change your Caller ID options:

1) Press and hold **call id**. The following screen appears.

```
1▶Auto Talk:Off
2 CIDCW      :On
3 Area Code:
```

2) Use ▲ and ▼ or a number key (1-3) to move the pointer to the selection that you would like to change.

Press **select** to toggle between "On" and "Off" for each setting.

3) After you have made your Caller ID selections, press **call id** and return the handset to the base.

Entering Your Area Code

If you enter a 3-digit area code number in the **Area Code** option, your local area code does not appear in Caller ID messages. Do not program this option, if your calling area requires 10-digit dialing. When reviewing Caller ID messages, you will see only the local seven digit number. For calls received from outside your local area code, you will see a full 10-digit number.

- 1) When the phone is in the standby mode, press and hold **call id**. The Caller ID setting screen appears.
- 2) Press **3** to select "Area Code" or press ▼ twice.
- 3) Press **select**.
- 4) Use the number keys (**0** to **9**) to enter the 3-digit area code.
- 5) Press **select**. A tone sounds and the displayed area code is entered.
- 6) Press **call id** to complete the setting. Or return the handset to the base unit to complete the setting. The handset returns to the standby mode.



When the area code has already been stored in memory, the stored area code will be displayed. To change it, use the **delete** and number keys to enter the new area code. Then press **select**. A confirmation tone sounds. To complete the setting, press **call id** or return the handset to the base unit.

```
1▶ Auto Talk: Off
2 CIDCW      : On
3 Area Code:
```

```
1 Auto Talk: Off
2 CIDCW      : On
3▶ Area Code:
```

```
1 Auto Talk: Off
2 CIDCW      : On
3 Area Code: ■
```

```
1 Auto Talk: Off
2 CIDCW      : On
3 Area Code: 817
```



If your calling area requires 10-digit dialing, do not program this option.

Making and Receiving Calls

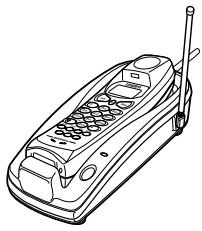
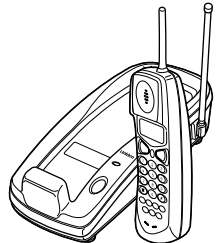
	Handset On Base 	Handset Off Base 
To answer a call	Pick up the handset (AutoTalk) or press talk .	Press any key (Any Key Answer) or press talk .
To make a call	1) Pick up the handset. 2) Press talk . 3) Listen for the dial tone. 4) Dial the number. <p style="text-align: center;">OR</p> 1) Pick up the handset. 2) Dial the number, then press talk .	1) Press talk . 2) Listen for the dial tone. 3) Dial the number. <p style="text-align: center;">OR</p> Dial the number, then press talk .
To hang up	Press talk , or return the handset to the base (AutoStandby).	Press talk .
To redial	1) Pick up the handset. 2) Press talk . 3) Listen for the dial tone. 4) Press redial/p .	1) Press talk . 2) Listen for the dial tone. 3) Press redial/p .

Terminology

Throughout this manual, terms such as Standby and Talk Mode are used. Below is the terminology explanation.

- **Standby Mode** - The handset is not in use, off the base, and **talk** has not been pressed. A dial tone is not present.
- **Talk Mode** - The handset is off the base and **talk** has been pressed enabling a dial tone.



Refer to page 12 "Setting Caller ID Options" to turn on Auto Talk feature if desired.

Adjusting the Handset Ringer and Earpiece Volume

Ringer tone and volume

When the phone is in standby mode, pressing the **vol ▼** or **▲** key on the handset selects the handset ringer volume and tone. There are two ringer tones each with two volume levels. Continue pressing the **vol ▼** or **▲** key to listen to all tone and volume levels. The phone keeps the last ringer tone and volume setting selected.

Earpiece volume

The handset earpiece volume settings (Low, Medium, High and Maximum) can only be adjusted during a call. Press **vol ▼** or **▲** to select Low, Medium, High and Maximum. When you hang up, the phone keeps the last volume setting selected.

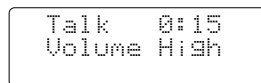

Redial

The **redial/p** key redials the last number dialed. The redialed number can be up to 32 digits long.

Tone Dialing Switch-over

Some telephone companies use equipment that require pulse dialing (sometimes referred to as rotary dialing). If you need to enter tone dialing digits, you can switch-over to tone dialing during the call. An example of this could be entering your bank account number after you have called your bank. The digits of your bank account can be sent using DTMF tones.

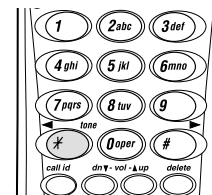

Initially make your call with the pulse dialing mode. Once your call connects, press ***/tone◀**. Enter the desired number (like in example above the bank account number). These digits will be sent as tone dialing. This special number can be stored in a memory location and used for Chain Dialing (See page 20.) Once the call ends, the tone mode is canceled and pulse dialing mode resumes.



The tone feature only applies when the dial mode is set to pulse.

Traveling Out-of-Range

During a call, as you begin to move your handset too far from your base unit, noise increases. If you pass the range limits of the base unit, your call will terminate within 30 seconds.

Selecting a Different Channel

If you encounter interference while using your phone, you can manually change the phone's channel for clear operation. Interference can come from appliances or other phones in your home. This function works only when the phone is in use.

During the course of a conversation, if you hear static or noise which makes it difficult to hear, press **chan**. "Scanning" appears on the display, indicating the phone is changing to another channel.

Page

To locate the handset (while it's off the base), press **page/find** on the base. The handset beeps for 60 seconds.

Paging is canceled when pressing any key or the handset is returned to the base.

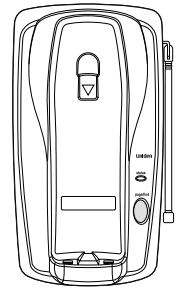

Flash and Call Waiting

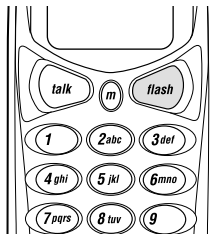

If you have "Call Waiting" service and a call waiting tone sounds while you are on a call, press **flash** to accept the waiting call. There is a short pause, then you will hear the new caller. To return to the original caller, press **flash** again.



You must subscribe through your local telephone company to receive Call Waiting Service.

Storing Phone Numbers and Names

Memory Dialing allows you to dial a number using just a few key strokes. Your EXI2960/EXI2965 stores up to 10 names/numbers in handset.

1) Press and hold **m** until "Memory Store" is displayed.

```
Memory Store
1▶
2
```

2) Press **▲** and **▼** or enter a number (0 - 9) to select the memory location where you would like to store the number.

```
Store Name
█
```

3) Press **select**. The following screen appears and a cursor flashes indicating that the display is ready for the name to be entered.

If this screen appears, the selected memory location is already stored. Then you must either change the entry in this location, clear the entry in this location, or select "Go Back" to choose another location.

```
▶Edit Memory 1
Delete Memory 1
Go Back
```

4) To enter a name (up to 14 characters), use the number keys.

- See the "Steps for entering names and special characters". (See page 18)
- Use **#▶** and *** /tone◀** to move the cursor to the desired location.
- Use **delete** to delete characters as needed.
- Press and hold **delete** to delete all the characters.
- If a name is not required, go to step 5.

```
Store Number
█
```

5) Press **select**. "Store Number" is displayed. The cursor flashes indicating that the display is ready for the number to be entered.

```
Store Number
8002971023█
```

6) Use the number keys to enter the phone number. The phone number cannot exceed 20 digits.

Use **redial/p** to enter pause in the dialing sequence.

The display shows a "P". Each pause counts as one digit and represents a two second delay of time between the digits as they are sent.

Use **delete** to delete digits as needed.

```
Memory 7 Stored
```

7) Press **select**. The handset beeps and displays the confirmation screen. Memory storage is complete. For example, if you store a name and number into memory location number 7, the display shows "Memory 7 Stored". If you store the number into memory location number 8, the display shows "Memory 8". After about 2 seconds, "Memory Store" is displayed. Repeat steps 2 - 7 to store more numbers.

```
Memory Store
7▶UNIDEN CORP
8 <Memory 8>
```

8) Press **m** to return to standby mode.



- In memory dialing operation, you must press a key within 20 seconds or the phone will return to standby. If you return the handset to the base, the phone will return to standby also.
- You have 20 seconds after pressing **m** to enter the number you wish to store. Otherwise, an error tone will sound.



The pause feature is useful for long distance calling, credit card dialing, or sequences that require a pause between digits.

Steps for Entering Names and Special Characters

Refer to the letters on the number keys to select the desired characters.

With each press of a numeric key, the displayed character appears in the following order : Upper case letters first, lower case letters next, and finally the number corresponding to the key.

Keys	Number of times key is pressed								
	1	2	3	4	5	6	7	8	9
1	1								
2abc	A	B	C	a	b	c	2		
3def	D	E	F	d	e	f	3		
4ghi	G	H	I	g	h	i	4		
5jkl	J	K	L	j	k	l	5		
6mno	M	N	O	m	n	o	6		
7pqrs	P	Q	R	S	P	q	r	s	7
8tuv	T	U	V	t	u	v	8		
9wxyz	W	X	Y	Z	w	x	y	z	9
0*	#	-	&	()	(blank)	0		

If you make a mistake while entering a name;

Use ***/tone** ◀ or **#** ▶ to move the cursor to the incorrect character. Press **delete** to erase the wrong character, then enter the correct character. To delete all characters, press and hold **delete**.

For example, to enter **Uniden**;

- 1) Pick up the handset. Press and hold **m**.
- 2) Enter a number or press ▲, ▼ to select a memory location number.
- 3) Press **select**.
- 4) Press **8** twice.
- 5) Press **6** five times.
- 6) Press **4** six times.

- 7) Press **3** four times, then press **#** ▶ to move the cursor to the right.



If the next character uses the same number key, you must press **#** ▶ to move the cursor over. Otherwise the next time you press the number key, it changes the character that was previously set.

- 8) Press **3** five times.
 - 9) Press **6** five times.
 - 10) When finished, press **select**.
- To continue to store the telephone number, proceed to step 6 on page 17.

Making Calls with Memory Dialing

Memory dialing from Standby Mode

- 1) Press **m**.
The handset displays your programmed memory locations.
- 2) Press ▼ and ▲ or enter the number (0 - 9) to select the memory location you would like to dial.
- 3) Press **talk**. "Talk" and the volume setting appear on the display. Then the displayed number is dialed.

```
1▶UNIDEN CORP
2 JOHN DOE
3 MOM AND DAD
```

```
-Talk-
0123456789012
```

Display a Programmed Number

Use # ▶ and */tone ◀ to toggle between the names display and the numbers display.

Program name		Program number
1 UNIDEN CORP	⇌▶⇌	1 8002971023
2 JOHN DOE		2 5452930
3▶MOM AND DAD	⇌◀⇌	3▶8175551212



When the stored phone number has 15 or more digits, "▶" is displayed next to the 13th digit. Press # ▶ to see the extra digits and */tone ◀ to return.

```
5 012345678901
6▶0118135543290+
7
```

Memory dialing from Talk Mode

- 1) Press **talk**. "Talk" and the volume setting appears.
- 2) Press **m**.
- 3) Enter a number (0 - 9) to select the memory location of the desired phone number. The selected phone number is displayed. Then the number is dialed.
- 4) To hang up, press **talk**.

```
-Talk-
```



```
Talk
Volume High
```

```
Talk 0:00
```

```
Talk 0:35
0123456789012
```



- If you press **select** before **talk**, you can confirm the name and the number stored in the selected memory location.
- To exit the memory function without dialing, press **m**. The handset returns to standby.
- Whenever you are using a menu screen, you must press a key within 20 seconds or the phone will return to standby.

Chain Dialing

The 10 memory locations on the handset are not limited to phone numbers. You may want to store in memory a group of numbers (up to 20 digits) that you need to enter once your call connects. This is referred to as Chain Dialing.

An example of this is a bank account number. Once you have called your bank, when you are prompted to enter the account number, simply press *m* and then the location where the special number has been stored.

Store your special number with identifying name in memory as you would a phone number. (Refer to "Storing Phone Numbers and Names" on page 17.) Enter a pause as necessary in the sequence.

A pause counts as one digit and represents a two second delay in time between digits as they are sent.

Editing a Stored Name and/or Phone Number

1) Press and hold *m* until "Memory Store" is displayed.

2) Press ▲ and ▼ or enter a number (0 - 9) to select the memory location you would like to edit.

```
Memory Store
1# UNIDEN CORP
2 JOHN DOE
```

3) Press *select*.

The following screen appears with the memory location number that you have selected in the display.

```
# Edit Memory 2
Delete Memory 2
Go Back
```

4) Press ▲ or ▼ to select "Edit Memory", then press *select*. The following screen appears. The cursor flashes indicating that the display is ready for the name to be edited. When a name has not been stored, the cursor appears at the beginning of the second line.

5) Use the number keys, **/tone* ◀, *#* ▶, or *delete* to edit the name. (See page 17.) To edit only the phone number, skip this step.

```
Store Name
UNIDEN CORP█
```

6) Press *select*. The following screen appears.

The cursor flashes indicating that the display is ready for the number to be edited.

7) Use the number key, *redial/p* or *delete* to edit the phone number. The phone number cannot exceed 20 digits. (See page 17.)

If you don't want to change the phone number, skip this step.

```
Store Number
8002971023█
```

8) Press **select**. The handset beeps and displays the confirmation screen. The memory storage is complete.

For example, if you store a name and number into memory location number 1, the display shows "Memory 1 Stored". After about 2 seconds, "Memory Store" is displayed.

```
Memory 1 Stored
```

```
Memory Store  
1 UNIDEN CORP  
2 JOHN DOE
```

9) Press **m** to return to standby mode.

Erasing a Stored Name and Phone Number

1) Press and hold **m** until "Memory Store" is displayed.

```
Memory Store  
1 UNIDEN CORP  
2 JOHN DOE
```

2) Press **▲** and **▼** or enter a number (0 - 9) to select the memory location you would like to edit.

```
Memory Store  
1 UNIDEN CORP  
2 JOHN DOE
```

3) Press **select**.

The following screen appears with the memory location number that you have selected in the display.

```
Edit Memory 2  
Delete Memory 2  
Go Back
```

4) Press **▼** to move the pointer down to "Delete Memory".

```
Edit Memory 2  
Delete Memory 2  
Go Back
```

5) Press **select**. The following confirmation screen appears.

```
Delete Memory 2?  
Yes  
No
```

6) Press **▲** to move the pointer to "Yes".

```
Memory 2 Deleted
```

7) Press **select** or **delete**.

The following screen appears.

```
Memory Store  
2 MOM AND DAD
```

8) After a few seconds the display returns to the

"Memory Store" screen.

You may delete the information in another memory location (return to step 2) or press **m** to return to standby.



Caller ID

You must subscribe to Caller ID service to use this feature.

When the telephone rings, the Caller ID feature allows you to view the caller's name and phone number on the display before you answer the phone.

The handset displays the phone number of the incoming call, the name, time, and the number of calls. Additionally, you can dial the displayed number and store the information for memory dialing. Make sure you have turned on the Caller ID/Call Waiting feature. (See page 12.)

When the Telephone Rings

1) When the Caller ID message is received, the display shows the caller's phone number along with the date and time. The incoming call information is stored in the Caller ID record. If the Caller ID service includes the caller's name, the caller's name appears on the display (up to 15 letters).

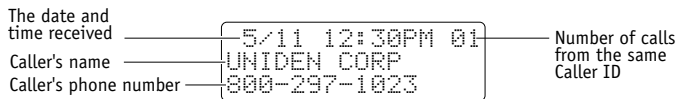

Here are some typical displays;

When the phone number and name data are received

```

5/11 12:30PM 01
UNIDEN CORP
800-297-1023

```

When invalid data is received

```

Incomplete Data

```

When a private name is received

```

5/11 12:30PM 01
Private Name
800-297-1023

```

When a private number is received

```

5/11 12:30PM 01
UNIDEN CORP
Private Number

```

When an unknown name is received

```

5/11 12:30PM 01
Unknown Name
800-297-1023

```

When an unknown number is received

```

5/11 12:30PM 01
UNIDEN CORP
Unknown Number

```



Data errors appear as "■".

2) When you pick up the phone, the display changes to "Talk". (AutoTalk feature is set to on.)



Viewing the Caller ID Message List

The Caller ID list stores information for up to 30 incoming calls - even unanswered calls.

1) Press *call id*.

The summary screen appears.

The screen shows the number of new messages and total messages.

```
New :01
Total:02
```

2) Press ▼ to display the latest Caller ID message.

```
5/17 12:30PM 03
UNIDEN CORP
800-297-1023
```

3) Press ▼ to see the next message. Or press ▲ to see previous message.

4) Press *call id* to return to standby.

Deleting Information from the Caller ID List

The EXI2960/EXI2965 stores up to 30 messages. If the phone receives the 31st message, the oldest one in the list is automatically deleted. Caller ID data can also be deleted manually.

Deleting a Caller ID message

1) Press *call id*. Display the message to be deleted from the Caller ID list by pressing ▲ or ▼.

```
5/17 12:30PM 03
UNIDEN CORP
800-297-1023
```

2) Press *delete*.

3) Press ▲ or ▼ to select "Yes" or "No".

```
Delete Message?
▶ Yes
No
```

4) Press *select* or *delete*.

When the pointer is at "Yes":

A tone sounds and the Caller ID message is deleted. The next Caller ID message is then displayed.

When the pointer is at "No":

The display returns to the Caller ID message.

- In Caller ID operation, if no key is pressed for more than 20 seconds, an error tone sounds and the telephone returns to the standby mode.

- If a call comes in via a telephone system that does not offer Caller ID service, no information is stored.

- Each message can be up to 15 characters for the phone number and the name.



- While using the "Delete All?" or "Delete Message?" screen if no key is pressed for more than 20 seconds, an error tone sounds and the telephone returns to standby.
- If you get an incoming call or page, the deleting operation is canceled and the telephone returns to standby so you can answer the call or page.

Deleting all Caller ID names/numbers

- 1) Press *call id*.
- 2) Press *delete*.
- 3) Press ▲ or ▼ to select "Yes" or "No".
- 4) Press *select* or *delete*.

When the pointer is at "Yes":

A tone sounds and all stored Caller ID messages are deleted.

```
New :01
Total:02
```

```
Delete All?
  Yes
#No
```

When the pointer is at "No":

The display returns to the summary screen.



- You cannot make a call from the Caller ID list if your EXI2960/EXI2965 is connected to private branch exchange (PBX).
- When a long distance call has been set, "1" appears in the display.

Using the Caller ID List

Calling a party from the Caller ID list

You can place a call from the Caller ID list. The EXI2960/EXI2965 stores up to 30 messages.

- 1) Press **call id**. Select the phone number that you want to dial by pressing ▲ or ▼.
- 2) Press **talk**. The displayed phone number dials automatically.

```
5/17 12:30PM 03
UNIDEN CORP
800-297-1023
```

```
Talk
8002971023
```

Long Distance calls and Area Code Setting/Cancellation

Pressing **1** while the incoming Caller ID information is displayed (in step 1) will place the prefix "1" in the display to set up for a long distance call. Pressing **3** will set or cancel an area code setting.

Dial edit

You can temporarily edit the Caller ID number that is displayed by pressing **select**. A cursor appears in the display. Press to move the cursor left, make your changes and then press . This will not change the number in the Caller ID list memory.

If you want to save this new number, store the information in memory. (See page 17.)



You can not store a Caller ID message if no phone number appears in the message.

Storing Caller ID messages in Memory dialing

Messages shown in the Caller ID list can be stored in memory dialing.

Using the incoming call information (i.e., Caller ID list), the phone number of the party on the Caller ID list can be stored in memory.

1) Press **call id**.

Select the phone number to be stored from the Caller ID list by pressing ▲ or ▼.

2) Press **m**.

```
5/17 12:30PM 03
UNIDEN CORP
800-297-1023
```

3) Press ▲ and ▼ or enter a number (0 - 9) to select the memory location to be stored.

```
Select Location
1 UNIDEN CORP
2 JONE DOE
```

4) Press **select**.

The number is stored in memory, and the display returns to the Caller ID list.

```
5/17 12:30PM 03
UNIDEN CORP
800-297-1023
```



If a message has already been stored in the selected memory number location, a confirmation screen is displayed. Press ▲ to select "Yes". Press **select** to overwrite. The display returns to the Caller ID list.

```
Replace Memory?
Yes
No
```

Changing the Digital Security Code

The digital security code is an identification code used to connect the handset and the base unit. Normally, setting the code is not necessary.

The first time you charge your handset, the security code is automatically set. (See "About the digital security code", page 3.)

In the rare situation that you suspect another cordless telephone is using the same security code, you can change the code.

- 1) Remove the handset from the base unit. Press and hold **page/find** on the base.
- 2) The handset begins emitting a paging sound. While holding **page/find** for at least 3 seconds, place the handset on the base unit. The paging sound stops.
Leave the handset on the base for more than 5 seconds or until the **status** LED stops flashing. A new random security code is set.



If the handset battery pack is completely discharged or the battery pack is removed, the digital security code will be lost. If this happens, a new security code is set automatically next time the battery pack is charged.



If the beltclip is attached, you can only charge the handset in the face down position.

Installing the Beltclip

To attach the beltclip

Insert the beltclip into the holes on each side of the handset. Press down until it clicks.

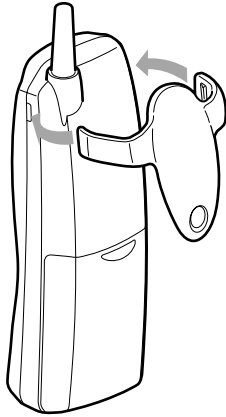

To remove the beltclip

Pull both sides of the beltclip to release the tabs from the holes.

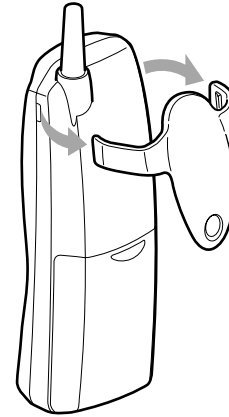

Headset Installation

Your phone may be used with an optional headset, the Uniden HS910. To use this feature, insert headset plug into the headset jack. Your phone is ready for hands-free conversations.

(Headset may be purchased by calling the Uniden Parts Department or visiting the web site. See Page 4.)

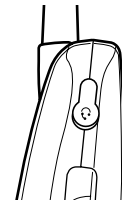

Note on Power Sources

Battery replacement and handling

When the operating time becomes short, even after a battery is recharged, please replace the battery.

With normal usage, your battery should last about one year. Please contact your place of purchase or the Uniden Parts Department for a replacement battery.

Power Failure

During the period that the power is off, you will not be able to make or receive calls with the telephone.

Caution

- Use the specified battery pack.
- Do not remove the battery from the handset to charge it.
- Never throw the battery into a fire, disassemble it, or heat it.
- Do not remove or damage the battery casing.

Maintenance

When slightly dirty

Wipe with a soft, dry cloth.

When very dirty

Wipe with a soft cloth that has been dampened with diluted, neutral detergent. Dry with a dry cloth.

When the charging terminals become dirty

Wipe with a dry cloth or a pencil eraser, if necessary.

RECYCLING NICKEL-CADMIUM BATTERIES



NICKEL-CADMIUM BATTERIES MUST BE DISPOSED OF PROPERLY.

Nickel-cadmium cells are used in the battery pack. Please take your used nickel-cadmium battery packs to a store that recycles nickel-cadmium batteries.

Caution

Do not use paint thinner, benzene, alcohol, or other chemical products. Doing so may discolor the surface of the telephone and damage the finish.

Troubleshooting

If your phone is not performing to your expectations, please try these simple steps first.

Symptom	Suggestion
The <i>status</i> LED won't light when the handset is placed in the base.	<ul style="list-style-type: none">• Make sure the AC adapter is plugged into the base and wall outlet.• Make sure the handset is properly seated in base.• Make sure the charging contacts on the handset and base are clean.
The audio sounds weak and/or scratchy.	<ul style="list-style-type: none">• Make sure that the base antenna is in a vertical position.• Move the handset and/or base to a different location away from metal objects or appliances and try again.• Press <i>chan</i> to help eliminate background noise.• Make sure that you are not too far from the base.
Can't make or receive calls.	<ul style="list-style-type: none">• Check both ends of the base telephone line cord.• Make sure the AC adapter is plugged into the base and wall outlet.• Disconnect the AC adapter for a few minutes, then reconnect it.• Reset the digital security code (See page 27).• Make sure that you are not too far from the base.
The handset doesn't ring or receive a page.	<ul style="list-style-type: none">• The battery pack may be weak. Charge the battery on the base unit for 15-20 hours.• The handset may be too far away from the base unit.• Place the base unit away from appliances or metal objects.• Reset the digital security code (See page 27).

Symptom	Suggestion
Severe noise interference.	<ul style="list-style-type: none"> • Keep the handset away from microwave ovens, computers, remote control toys, wireless microphones, alarm systems, intercoms, room monitors, fluorescent lights, and electrical appliances. • Move to another location or turn off the source of interference.
The Caller ID does not display.	<ul style="list-style-type: none"> • The handset was picked up before the second ring. • The call was placed through a switch board. • Call your local telephone company to verify your Caller ID service is current. • Charge the handset.
If you still have a problem.	<ul style="list-style-type: none"> • Call our customer hot line at 1-800-297-1023.

General Information

The phone complies with FCC Parts 15 and 68.
 Operating temperature: -10° to 50°C (+14°F to +122°F)

AC Adapter Information

AC Adapter part number: AD-310
 Input Voltage: 120V AC 60Hz
 Output Voltage: 9V DC 210 mA

Battery Information

Battery part number: BT-905
 Capacity: 600 mAh, 3.6V
 Battery use time (per charge)
 From fully charged -
 Talk mode duration: 7 hours
 Standby mode duration: 14 days



If the handset is left off of the base, the actual Talk mode duration will be reduced respective to the amount of time the handset is off the base.

Recharge your phone on a regular basis by returning the handset to the base after each phone call. When the operating time becomes short, even after the battery is recharged, please replace the battery. With normal usage, the battery should last about one year.

Replacement batteries may be purchased at your local Uniden dealer or by contacting the Uniden Parts Department (800) 554-3988. Hours are from 7:00 a.m. to 5:00 p.m. Central Time, Monday through Friday. We can also be reached on the web at www.uniden.com

Specifications, features, and availability of optional accessories are all subject to change without prior notice.

At Uniden, we'll take care of you!

If you need any assistance with this product, please call our Customer Hotline at

1-800-297-1023

PLEASE DO NOT RETURN THIS PRODUCT TO THE PLACE OF PURCHASE.

Our Uniden representatives will be happy to help you with any matters regarding the operation of this unit, available accessories, or any other related matters.

Thank you for purchasing a Uniden product.

Hours: M-F 7:00 AM to 7:00 PM CST.

Index

A

- AC adapter information31
- Adjusting ringer and earpiece volume15

B

- Battery pack
 - Information31
 - Installing6
 - Maintenance7, 29
 - Preparing and charging 8
 - Replacement and handling 29
- Beltclip installation..... 28

C

- Caller ID
 - Caller ID service 22
 - Call Waiting..... 16
 - Deleting 23
 - Setting Caller ID options 12
 - Using..... 25
 - Viewing 23
- Channel16
- Connection 7

D

- Dialing mode9
- Digital security code 3, 27

E, F, G

- Earpiece volume 15

H

- Headset installation 28

I, J, K, L

- Interference30

M, N, O

- Maintenance 29
- Making a call 14
- Memory dialing
 - Editing a stored name and phone number 20
 - Erasing a stored name and phone number 21
 - Making calls with memory dialing..... 19
 - Storing phone numbers and names 17
- Mounting on a wall.....10

P, Q

- Package contents 4
- Paging 16

R

- Receiving a call 14
- Redialing a call 14, 15
- Ringer tone and volume 15

S

- Setting up the Phone..... 5
- Setting up the Handset 6

T, U, V, W, X, Y, Z

- Troubleshooting 30

A World Without Wires | **Uniden**

Covered under one or more of the following U.S. patents:

4,511,761	4,523,058	4,595,795	4,797,519	5,381,490	5,428,890
5,434,905	5,491,745	5,533,015	5,574,727	5,650,790	5,665,299
5,691,790	5,693,981	5,671,248	5,717,312	5,754,407	5,768,345
5,787,356	5,838,721	5,864,619	5,893,034	5,912,968	5,915,227
5,929,590	5,930,720	5,965,358	5,967,330		

© 2001 Uniden America Corporation, Fort Worth, TX
All rights reserved.

UC-Z201310ZZ

Uniden